

# **GALTAROSS ALLUMINIO**

PROFILI SPECIALI

## CATALOGO PROFILI



[www.galtarossalluminio.com](http://www.galtarossalluminio.com)

## PROPRIETA' FISICHE PHYSICAL PROPERTIES

LEGA ALLOY	DENSITA' DENSITY Kg/dm <sup>3</sup>	MODULO DI ELASTICITA' MODULUS OF ELASTICITY kN/mm <sup>2</sup>	COEFFICIENTE DI DILATAZIONE TERMICA THERMAL EXPANSION COEFFICIENT μ°C <sup>-1</sup> 20-100°C	CONDUCIBILITA' TERMICA THERMAL CONDUCTIVITY W/(m-K) 20°C	CALORE SPECIFICO SPECIFIC HEAT J/(Kg-k) 0-100°C	RESISTIVITA' RESISTIVITY n Ω μ	RANGE TEMPERATURA DI FUSIONE MELTING TEMPERA- TURE RANGE °C
6060	2.70	69	23	200	880-900	33	600-655
6063	2.70	69	23	200	880-900	33	600-655
6005A	270	69	23.3	182	960	36	605-655
6463	2.70	67	24	195	850	33	610-650
6082	2.71	69	23	180	897	38	580-650
6101	2.70	69	24	218	895	30	620-655

## COMPARAZIONE LEGHE ALLOY COMPARISON

DESIGNAZIONE NUMERICA IDENTIFICATION NUMBER	D		USA	I	
	DIN	DIN Werkstoff Nr	AA	UNI	
6060	Al Mg Si 0,5	3.3206	6060	3569	9006/1
6060	Al Mg Si 0,5	3.3206	6060	3569	9006/1
6005A	Al Mg Si 0,7	3.3210	6005A		9006/6
6463	Al Mg Si 0,5	3.3206	6463	6359	9006/5
6082	Al Mg Si 1	3.2315	6082	3571	9006/4
6101	E Al Mg Si 0,5	3.3207	6101	3570	9006/3

## CARATTERISTICHE MECCANICHE MECHANICAL SPECIFICATIONS

DESIGNAZIONE NUMERICA IDENTIFICATION NUMBER	STATO DI FORNITURA STATE OF SUPPLY	CARATTERISTICHE MECCANICHE MIN MIN MECHANICAL SPECIFICATIONS			
		Rm N/mm <sup>2</sup>	Rp (02) N/mm <sup>2</sup>	A%	HB
6060	F	120	70	22	40
	T4	130	80	16	45
	T5	185	145	11	55-70
	T6	205	165	10	60-80
6063	T6	245	195	10	75
6005A	T4	160	90	14	45
	T6	260	215	8	80
6463	T4	130	80	16	45
	T5	185	145	11	55-70
6082	F	150	-	16	45
	T4	205	110	14	50
	T6	275	200	12	85
	T6	310	260	10	95
6101	F	120	-	15	40
	T4	150	80	14	45
	T6	210	180	12	65

## COMPOSIZIONE CHIMICA % CHEMICAL COMPOSITION %

DESIGNAZIONE NUMERICA IDENTIFICATION NUMBER	Al	Mg	Si	Fe	Mn	Zn	Cu	IMPURITA' IMPURITIES
6060	Resto	0,30-0,60	0,30-0,60	0,30	0,10	0,10	0,10	0,05-0,15
6063	Resto	0,40-0,65	0,40-0,65	0,30	0,10	0,10	0,10	0,05-0,15
6005A	Resto	0,40-0,70	0,50-0,90	0,30	0,10	0,10	0,30	0,05-0,15
6463	Resto	0,40-0,65	0,30-0,50	0,13	0,05	0,10	0,05-0,20	0,02-0,10
6082	Resto	0,60-1,20	0,70-1,30	0,30	0,40-1,00	0,10	0,10	0,05-0,15
6101	Resto	0,40-0,60	0,35-0,60	0,30	0,03	0,05	0,05	0,05-0,15

N.B. Tutti i dati riportati sul presente catalogo sono indicativi e non impegnativi. La società si riserva la facoltà di apportare in qualsiasi momento cambiamenti atti a migliorare i prodotti.

NOTE: All the details shown in this catalogue are approximate and not binding. The company reserves the right to make any changes at any time for the purpose of upgrading its products.

## TUBI TONDI

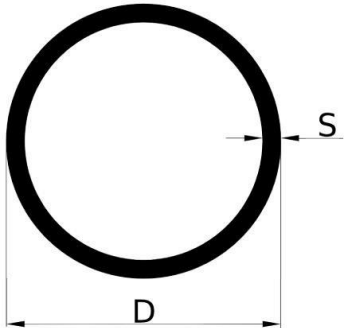

### LEGA EN AW - 6060

D ( mm )	S ( mm )	Kg/ml
10	1	0,075
10	1,5	0,108
13	1,5	0,146
16	1,5	0,183
20	2	0,305
25	1,5	0,299
30	1,5	0,362
32	1,5	0,391
35	1,5	0,427
40	1,5	0,489
50	2	0,813
60	1,5	0,742
60	2	0,982
70	1,5	0,872
100	3	2,467

## TUBI QUADRI

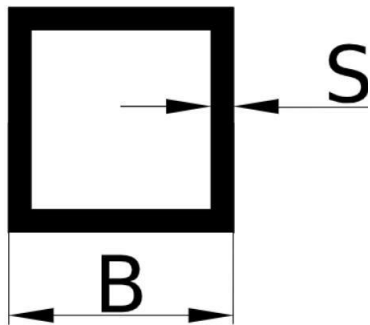

**LEGA EN AW - 6060**

<b>B ( mm )</b>	<b>S ( mm )</b>	<b>Kg/ml</b>
15	1,5	0,219
20	1,5	0,295
25	1,2 Ragg 1,5	0,307
25	1,5	0,380
30	1,5	0,480
35	1,5	0,543
40	1,5	0,635
40	2	0,820
45	2	0,929
50	2	1,037
60	2	1,253
70	2	1,469
80	2	1,685
100	2	2,117
120	2,5	3,172
150	3	4,763
200	4 Ragg 10	8,570

# TUBI RETTANGOLARI

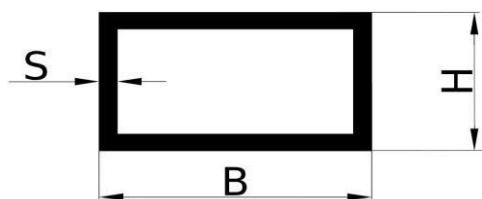

LEGA EN AW - 6060

B ( mm )	H ( mm )	S ( mm )	Kg/ml
20	10	1,5	0,219
30	20	1,5	0,381
40	15	1,5	0,421
40	20	1,5	0,462
40	20	2	0,605
40	25	2	0,659
40	30	1,5	0,550
50	20	1,5	0,543
50	20	2	0,713
50	25	2	0,766
50	30	2	0,820
60	20	2	0,821
60	40	2	1,037
70	50	2	1,253
100	30	2	1,361
100	50	2	1,570
120	20	2	1,468
120	40	2	1,685
120	50	4	3,440
120	60	4	3,715
150	50	2	2,116
200	40	2	2,549
200	50	3	3,952
200	100	3	4,762

## ANGOLARI LATI DISUGUALI

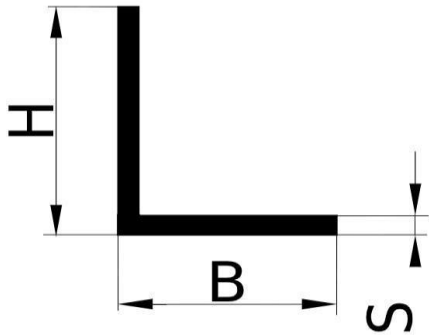

**LEGA EN AW - 6060**

<b>B ( mm )</b>	<b>H ( mm )</b>	<b>S ( mm )</b>	<b>Kg/ml</b>
30	10	2	0,206
30	15	1,5	0,189
30	15	2	0,233
30	20	2	0,260
40	20	2	0,314
50	20	2	0,367
50	25	2	0,395
50	40	2	0,476
80	40	2	0,637
100	20	2	0,638
100	30	2	0,702
100	50	2	0,800
120	20	2	0,746

**BARRE PIATTE**

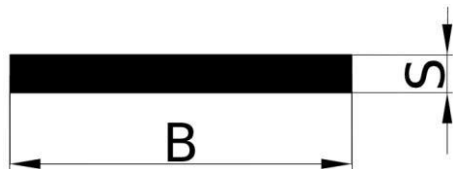

B ( mm )	S ( mm )	Kg/ml
20	2	0,108
25	3	0,203
25	4	0,270
25	5	0,337
25	6	0,405
30	2	0,162
30	4	0,324
30	5	0,405
30	6	0,486

**PROFILI AD U**

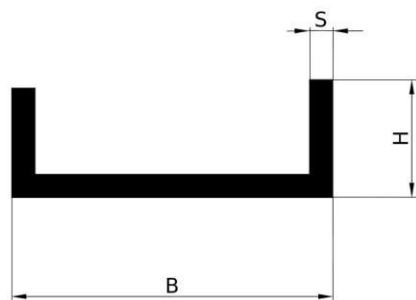

**LEGA EN AW - 6060**

B ( mm )	H ( mm )	S ( mm )	Kg/ml
20	30	2	0,410
25	25	2	0,383
25	50	2	0,653
30	30	2	0,464
40	40	2	0,630
80	50	3	1,409

**PROFILI T**

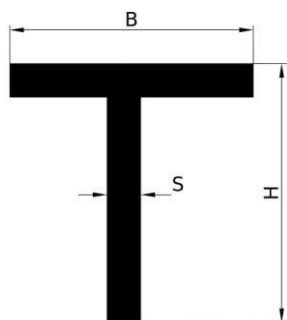

**LEGA EN AW - 6060**

B ( mm )	H ( mm )	S ( mm )	Kg/ml
119	51	2	0,907

# PROFILI PER TENDE DA SOLE

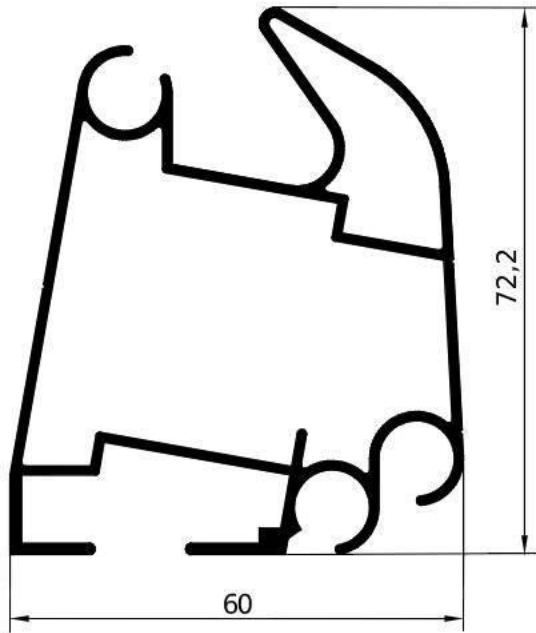

**GA1051 – gr/ml 1241**  
 L/mm. 4000-4500-5000-  
 5500-6000-6500-7000  
 PACCO / 2 BARRE

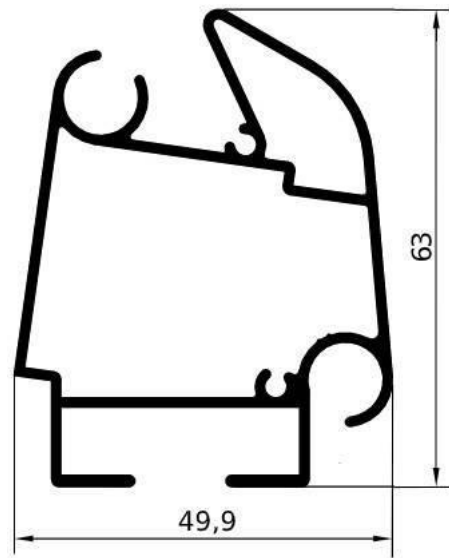

**GA1050 – gr/ml 1037**  
 L/mm. 4000-5000  
 6000-7000  
 PACCO / 2 BARRE

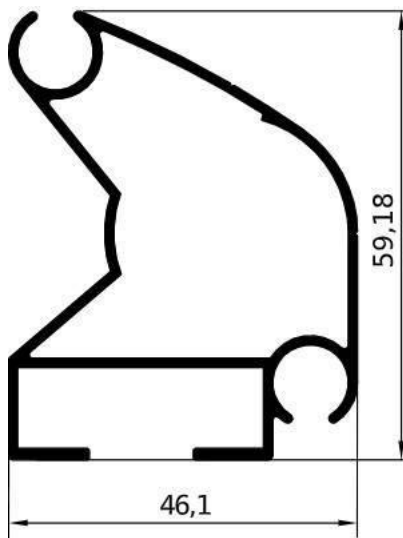

**GA1510 – gr/ml 800**  
 L/mm. 4000-5000  
 6000-7000  
 PACCO / 2 BARRE

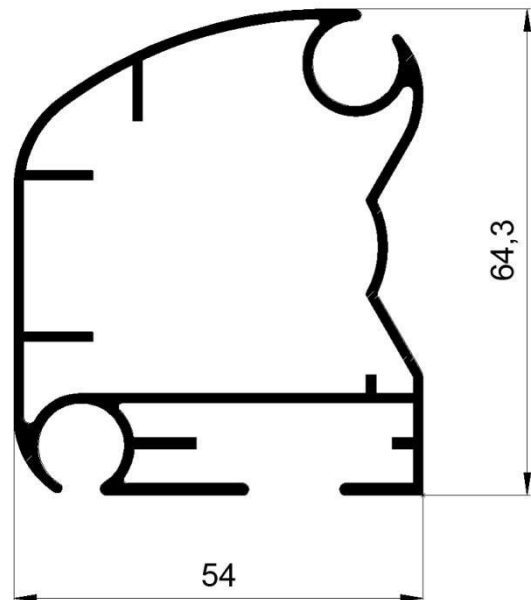

**GA1053 – gr/ml 1196**  
 L/mm. 4000-5000  
 6000-7000  
 PACCO / 2 BARRE



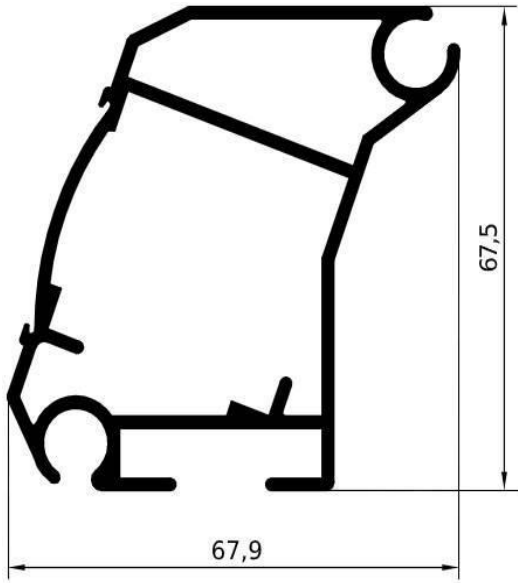

<b>GA1004 – gr/ml 1453</b>
L/mm. 4000-5000 6000-7000
PACCO / 2 BARRE

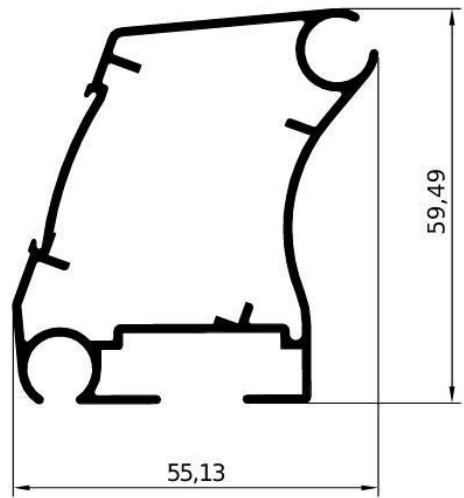

<b>GA1669 – gr/ml 886</b>
L/mm. 4000-5000 6000-7000
PACCO / 2 BARRE

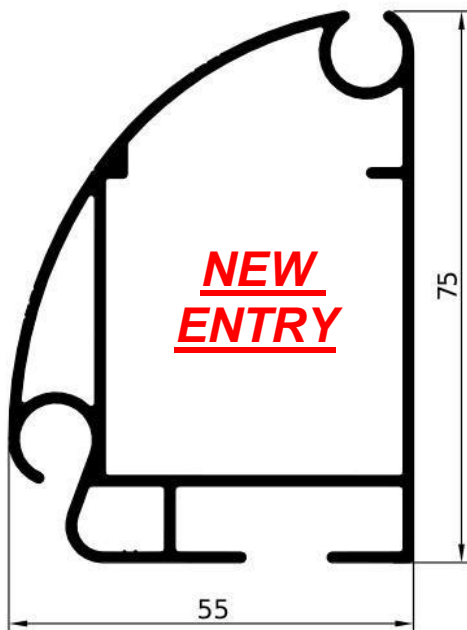

<b>GA1694 – gr/ml 1306</b>
L/mm. 4000-5000 6000-7000
PACCO / 2 BARRE

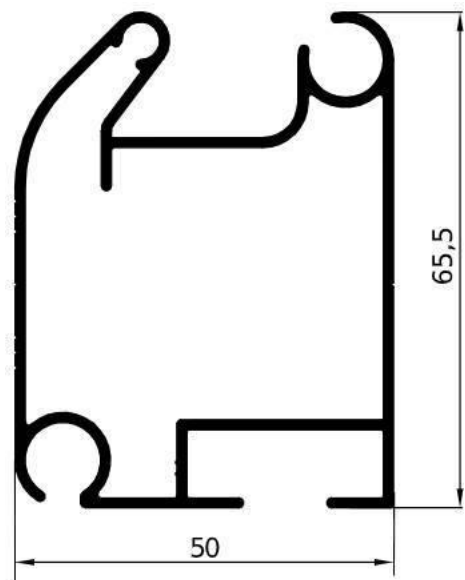

<b>GA1515 – gr/ml 1078</b>
L/mm. 4000-5000 6000-7000
PACCO / 2 BARRE

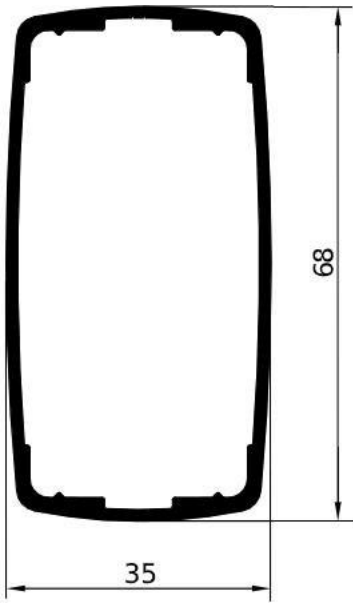

<b>GA1508 – gr/ml 906</b>
L/mm.7000
PACCO / 2 BARRE

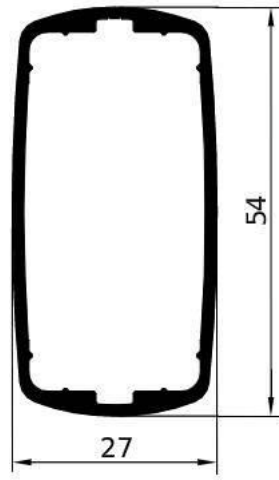

<b>GA1501 – gr/ml 702</b>
L/mm. 7000
PACCO / 2 BARRE

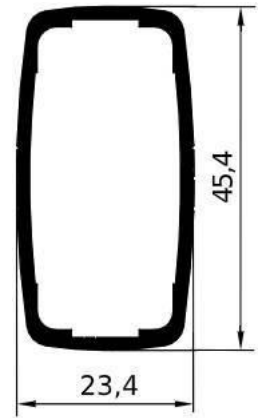

<b>GA1507 – gr/ml 581</b>
L/mm. 7000
PACCO / 2 BARRE

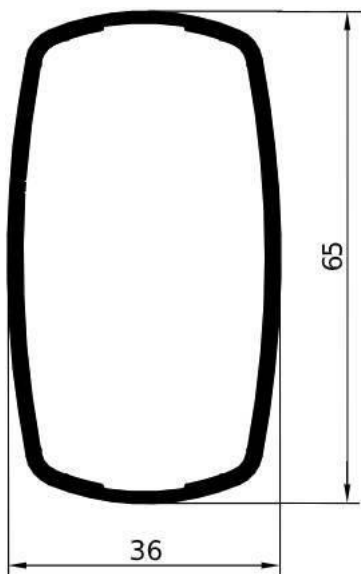

<b>GA1511 – gr/ml 899</b>
L/mm.7000
PACCO / 2 BARRE

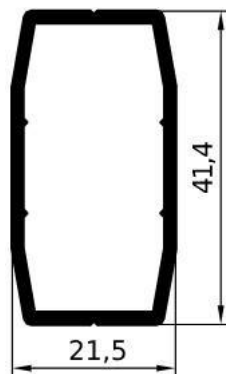

<b>GA1677 – gr/ml 450</b>
L/mm.6000
PACCO / 5 BARRE

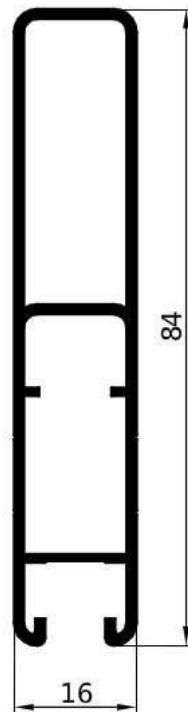

<b>GA1517 – gr/ml 701</b>
L/mm.6000
PACCO / 5 BARRE

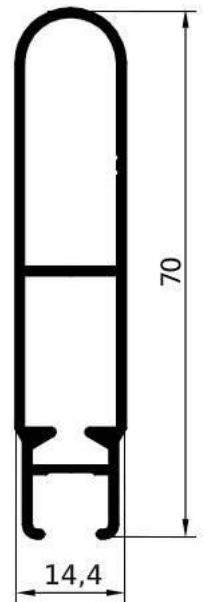

<b>GA1607 – gr/ml 491</b>
L/mm.6000
PACCO / 5 BARRE

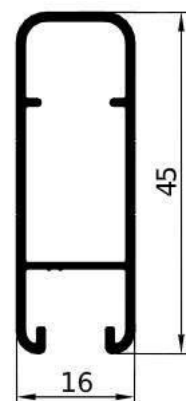
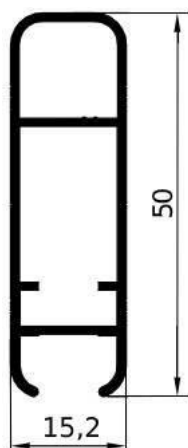
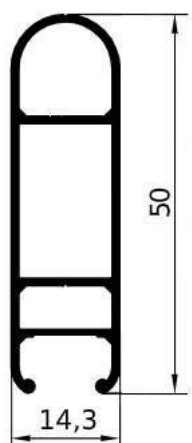
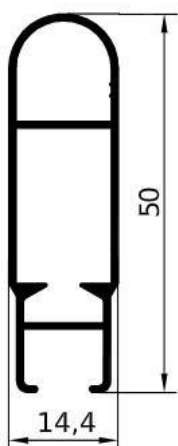

**GA1005 – gr/ml 410**

L/mm.7000

PACCO / 5 BARRE

**GA1001 – gr/ml 410**

L/mm.7000

PACCO / 5 BARRE

**GA1003 – gr/ml 440**

L/mm.7000

PACCO / 5 BARRE

**GA1006 – gr/ml 400**

L/mm.7000

PACCO / 5 BARRE

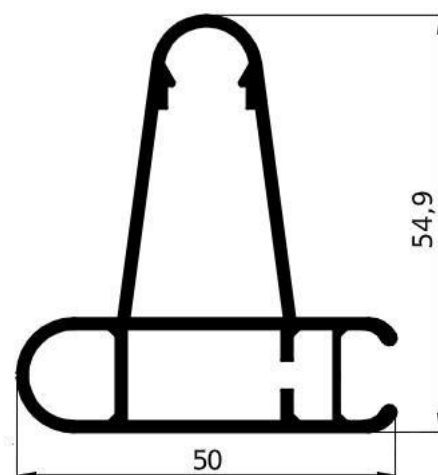
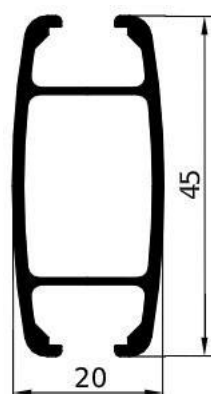
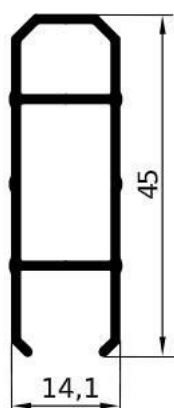
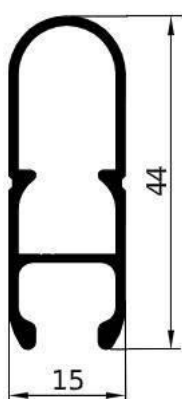

**GA1007 – gr/ml 380**

L/mm.7000

PACCO / 5 BARRE

**GA1008 – gr/ml 340**

L/mm.7000

PACCO / 5 BARRE

**GA1577 – gr/ml 518**

L/mm. Su richiesta

PACCO / 5 BARRE

**GA1573 – gr/ml 823**

L/mm.7000

PACCO / 4 BARRE

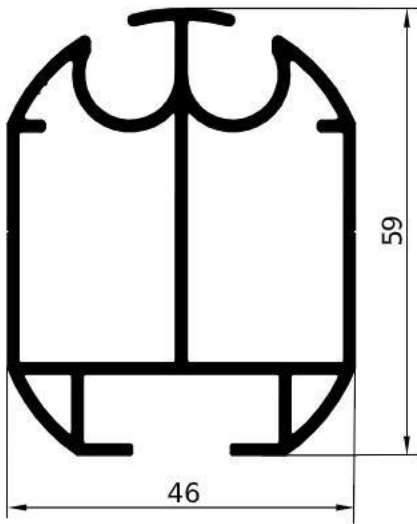

<b>GA1553 – gr/ml 1253</b>
L/mm.7000
PACCO / 2 BARRE

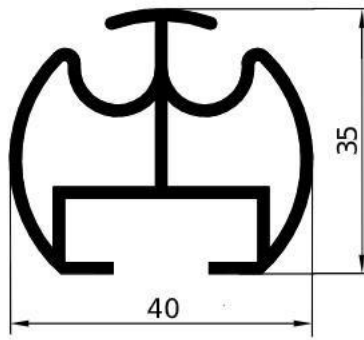

<b>GA1558 – gr/ml 801</b>
L/mm.7000
PACCO / 5 BARRE

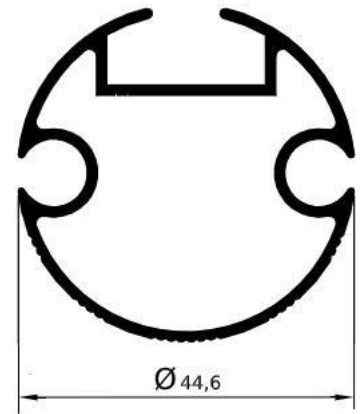

<b>GA1512 – gr/ml 702</b>
L/mm.5000-6000-7000
PACCO / 5 BARRE

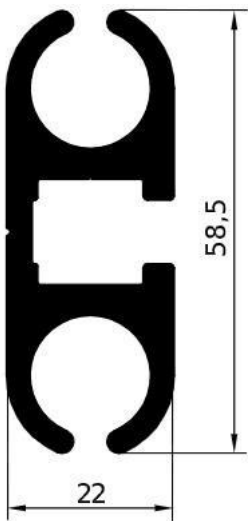

<b>GA1526 – gr/ml 1479</b>
L/mm.7000
PACCO / 4 BARRE

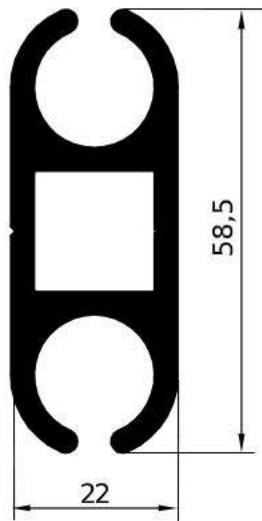

<b>GA1052 – gr/ml 1425</b>
L/mm.7000
PACCO / 4 BARRE

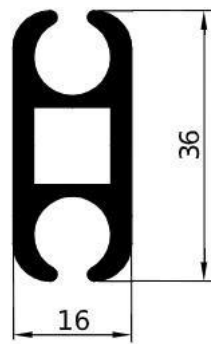

<b>GA1599 – gr/ml 694</b>
L/mm.7000
PACCO / 5 BARRE

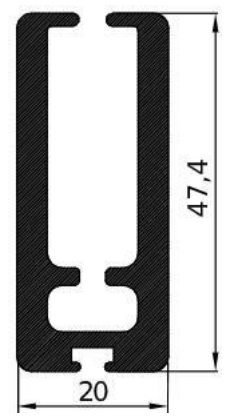

<b>GA1638 – gr/ml 1245</b>
L/mm.7000
PACCO / 4 BARRE

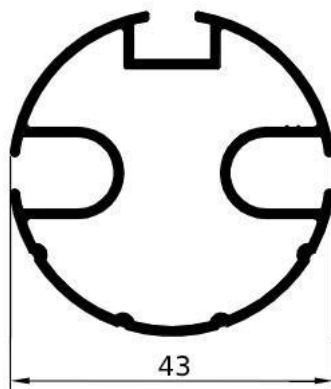

**GA1525 – gr/ml 662**  
 L/mm.4000-5000-  
 6000-7000  
 PACCO / 5 BARRE

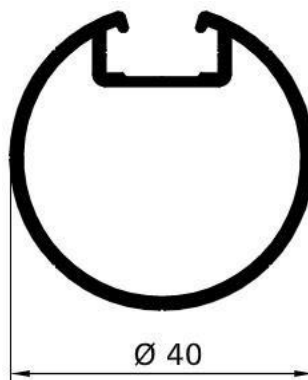

**GA1556 – gr/ml558**  
 L/mm.Su richiesta  
 PACCO / 5 BARRE

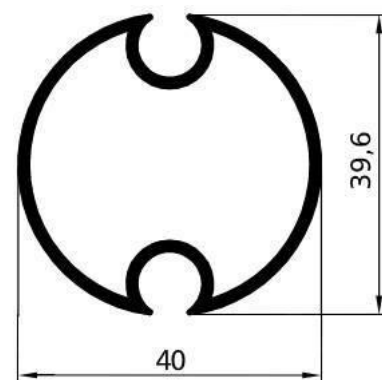

**GA1539 – gr/ml 612**  
 L/mm.7000  
 PACCO / 5 BARRE

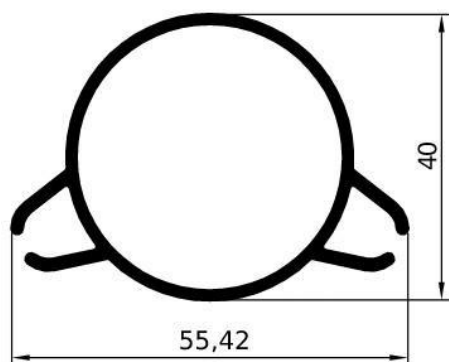

**GA1513 – gr/ml 609**  
 L/mm.7000  
 PACCO / 5 BARRE

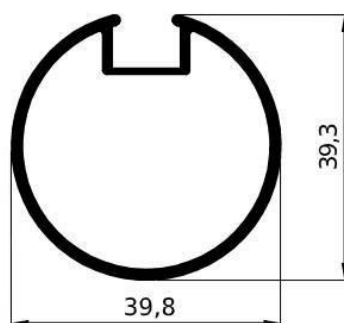

**GA1002 – gr/ml 530**  
 L/mm.7000  
 PACCO / 5 BARRE

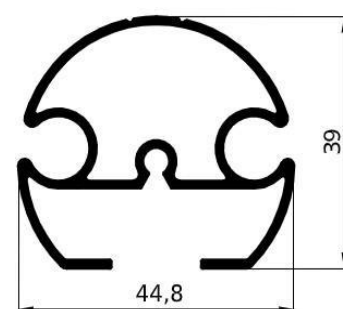

**GA1055 – gr/ml 679**  
 L/mm.5000-7000  
 PACCO / 5 BARRE

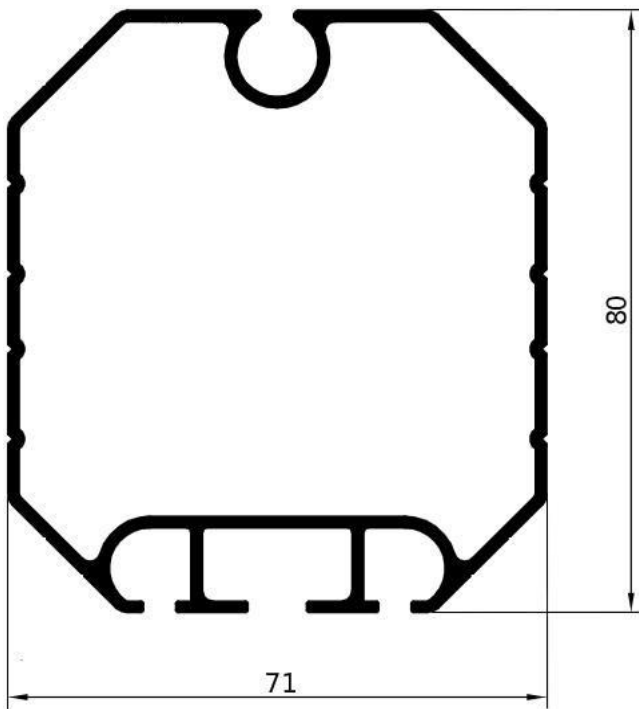

<b>GA1522 – gr/ml 1250</b>
L/mm.7000
PACCO / 2 BARRE

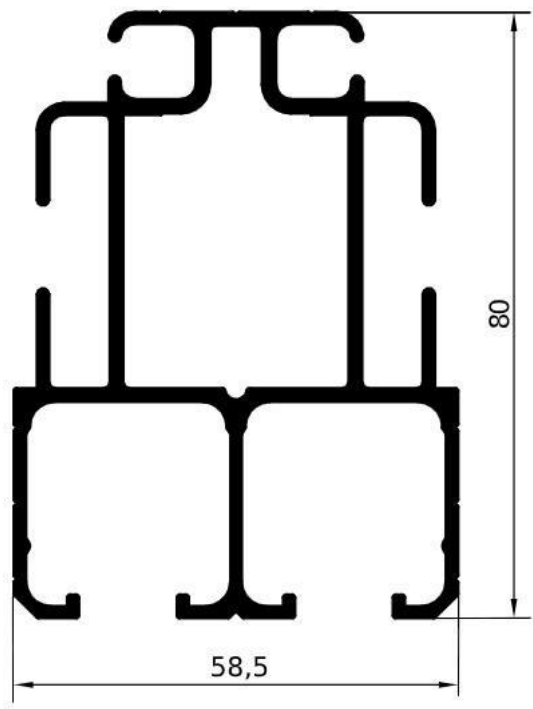

<b>GA1523 – gr/ml 1786</b>
L/mm.7000
PACCO / 2 BARRE

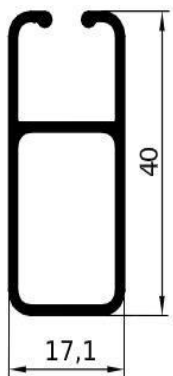

<b>GA1054 – gr/ml 386</b>
L/mm.6000
PACCO / 5 BARRE

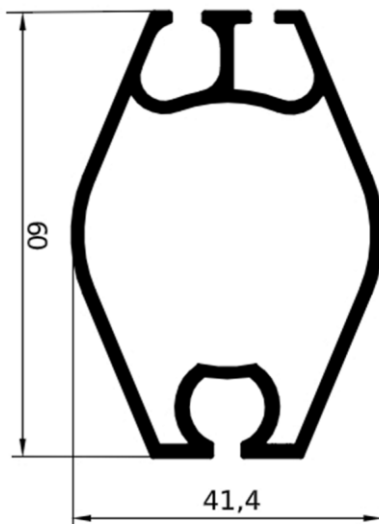

<b>GA1528 – gr/ml 852</b>
L/mm. 7000
PACCO / 3 BARRE

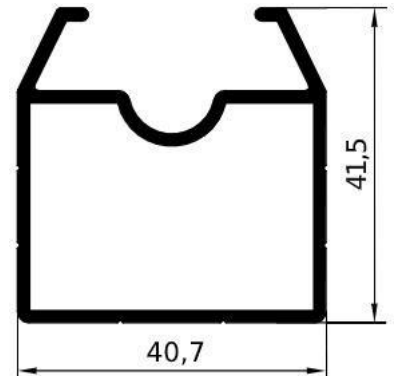

<b>GA1519 – gr/ml 686</b>
L/mm.7000
PACCO / 3 BARRE

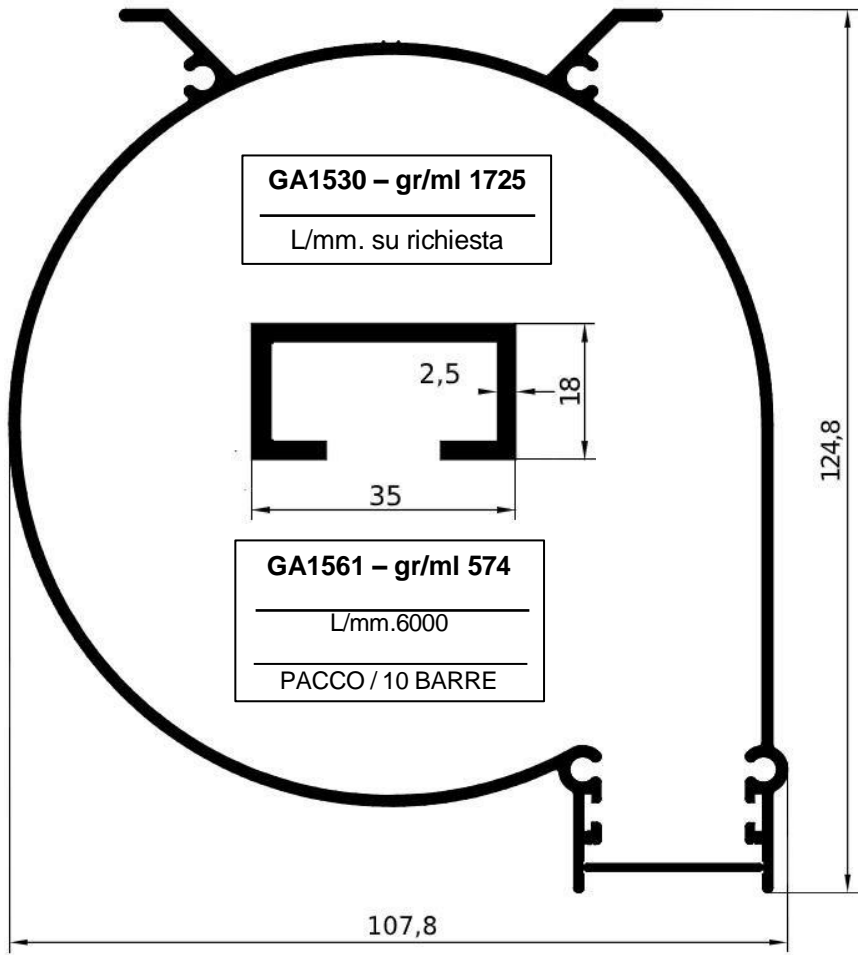
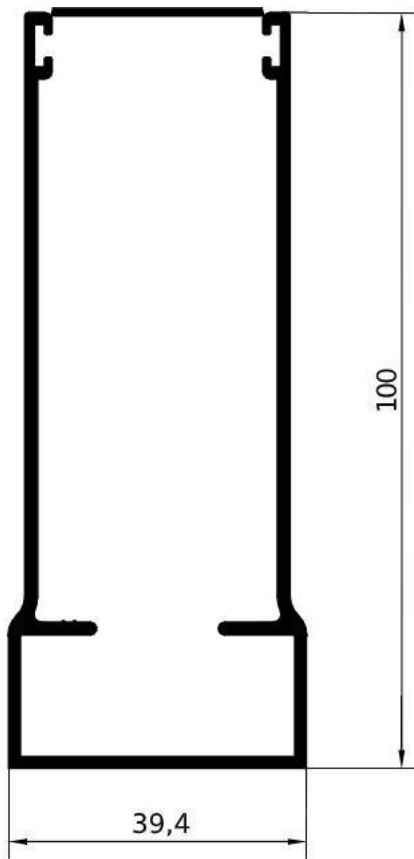

**GA1509 – gr/ml 1293**  
 L/mm.5000-7000  
 PACCO / 3 BARRE

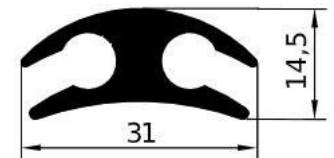
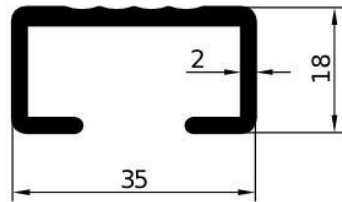

**GA1693 – gr/ml 460**  
 L/mm.6000  
 PACCO / 10 BARRE

**GA1601 – gr/ml 499**  
 L/mm.5000-7000  
 PACCO / 8 BARRE

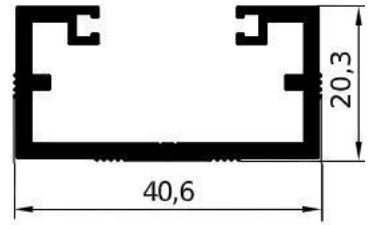
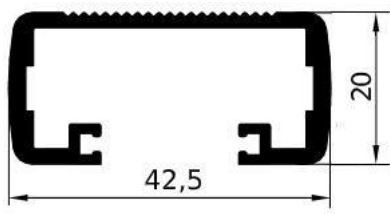
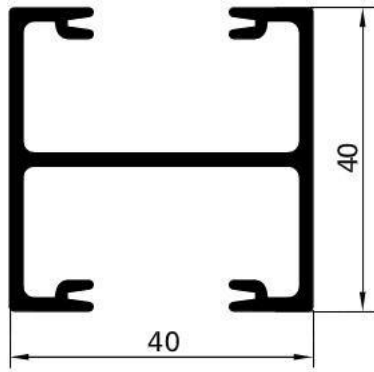

**GA1554 – gr/ml 779**  
 L/mm.6000  
 PACCO / 3 BARRE

**GA1531 – gr/ml 585**  
 L/mm.7000  
 PACCO / 10 BARRE

**GA1598 – gr/ml 606**  
 L/mm.Su richiesta

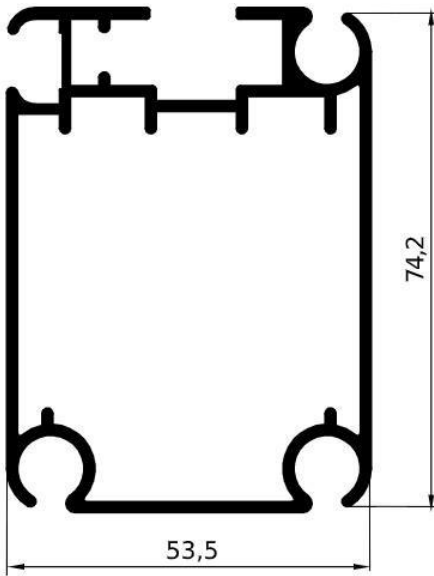

**GA1602 – gr/ml 1350**  
 L/mm.5000 - 7000  
 PACCO / 2 BARRE

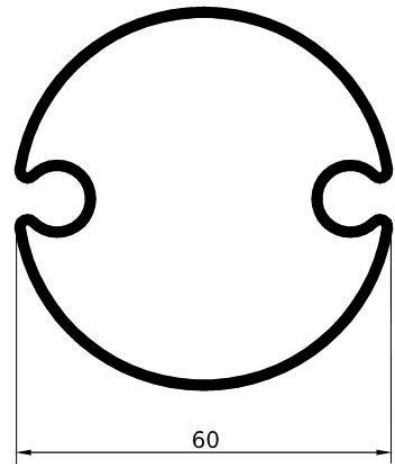

**GA1603 – gr/ml 921**  
 L/mm.7000  
 PACCO / 3 BARRE

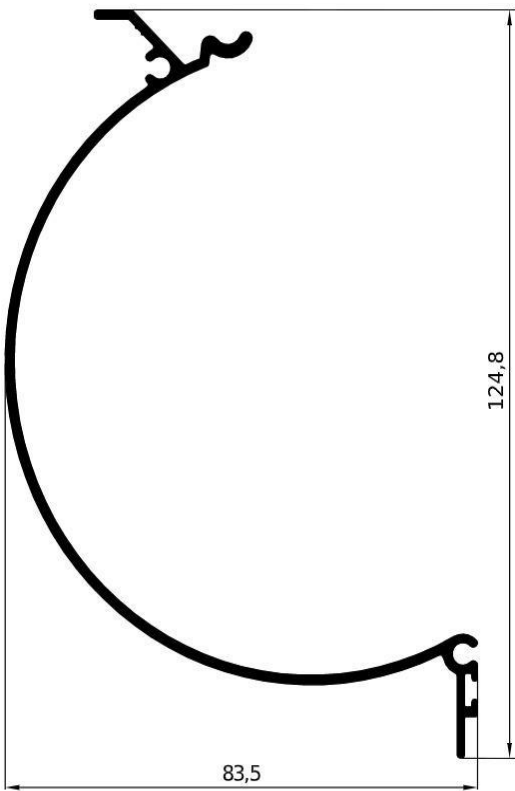

**GA1622 – gr/ml 1028**  
 L/mm.5000-7000  
 PACCO / 2 BARRE

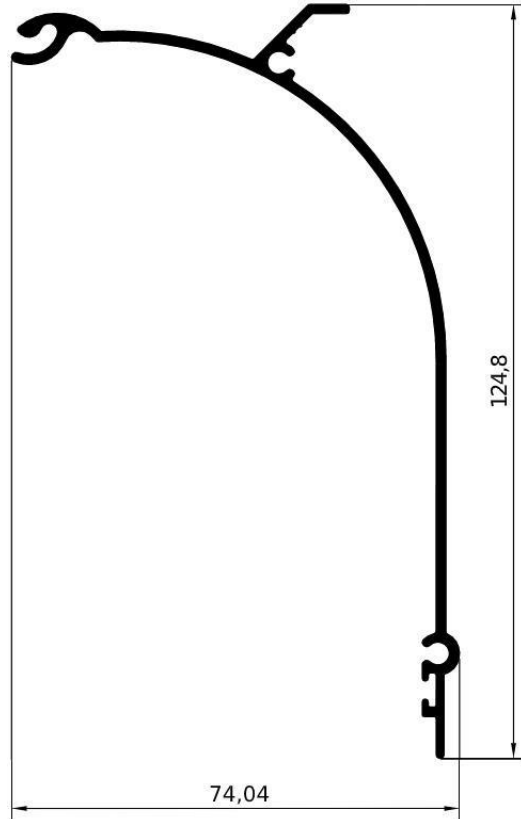

**GA1621 – gr/ml 920**  
 L/mm.5000-7000  
 PACCO / 2 BARRE



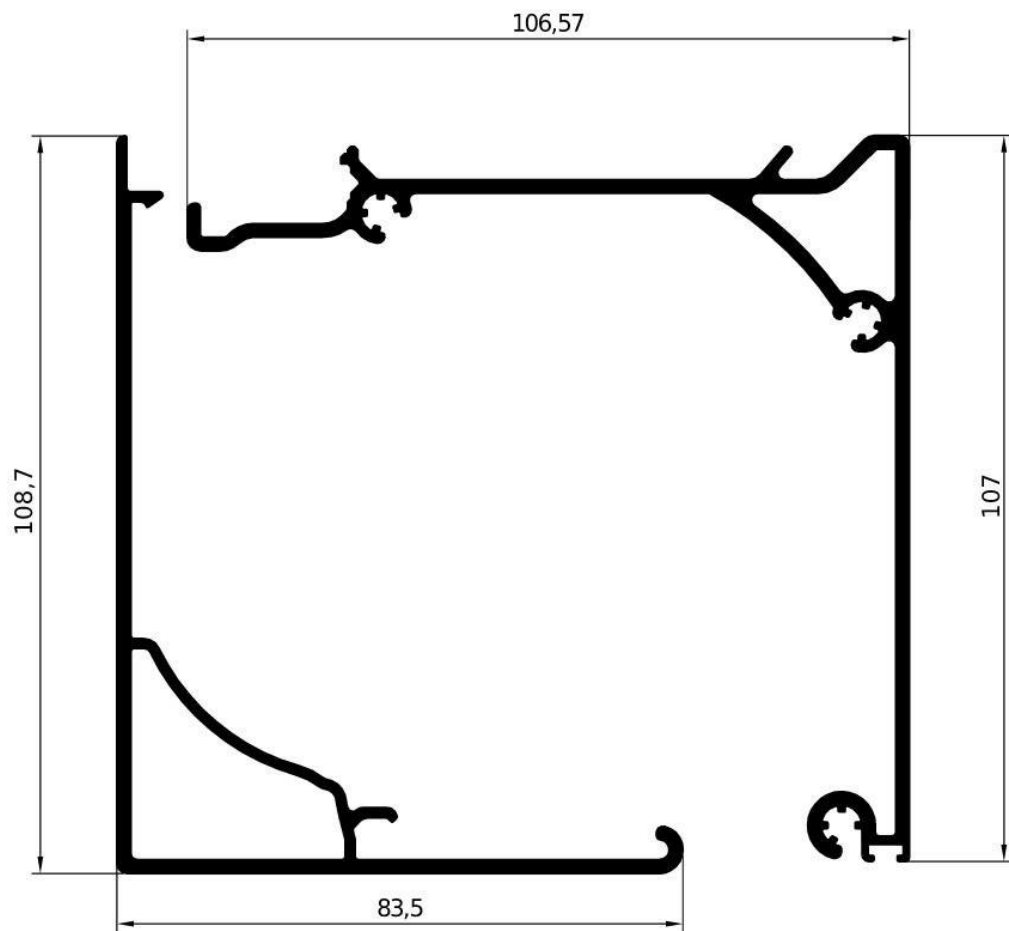

<b>GA1683 – gr/ml 1282 CASS VEGA</b>
L/mm.7000
PACCO / 1 BARRA

<b>GA1684 – gr/ml 1697 CASS VEGA</b>
L/mm.7000
PACCO / 1 BARRA

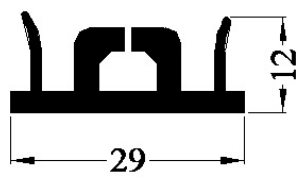
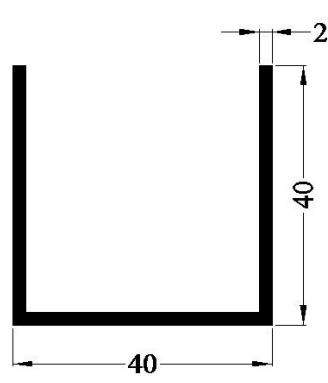
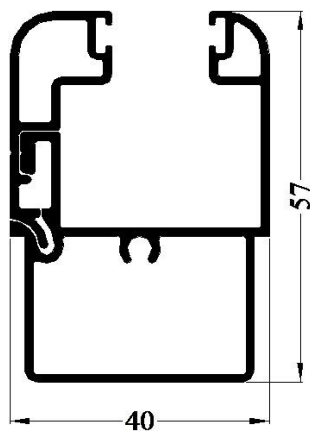

<b>AC135 – Kit Guida Zip</b>
L/ mm.6000
PACCO / 1 BARRA

<b>AC135/A – GUIDA ZIP mm.29 PER AC135</b>
L/ mm.6000
PACCO / 1 BARRA

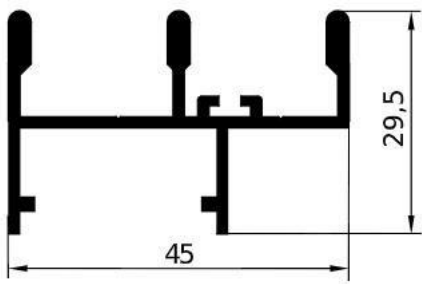

**GA1536 – gr/ml 607**  
 L/mm.6500  
 PACCO / 10 BARRE

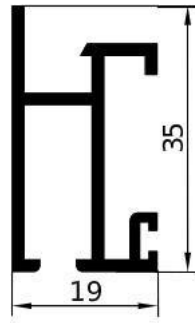

**GA1537 – gr/ml 424**  
 L/mm.6500  
 PACCO / 10 BARRE

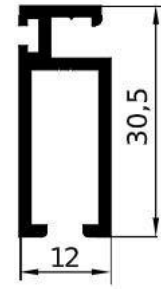

**GA1538 – gr/ml 324**  
 L/mm.6500  
 PACCO / 10 BARRE

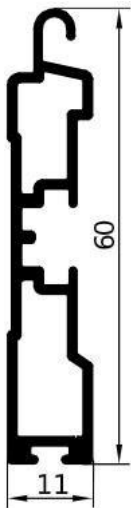

**GA1624 – gr/ml 470**  
 L/mm.6200  
 PACCO / 5 BARRE

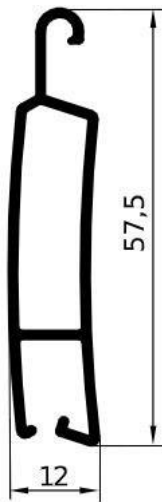

**GA1514 – gr/ml 351**  
 L/mm.6000  
 PACCO / 5 BARRE

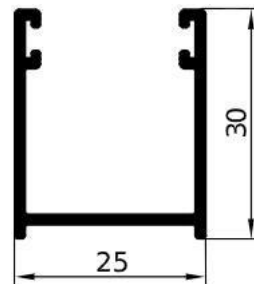

**GA1625 – gr/ml 303**  
 L/mm.6500  
 PACCO / 10 BARRE

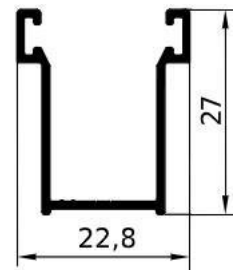

**GA1626 – gr/ml 218**  
 L/mm.6500  
 PACCO / 10 BARRE

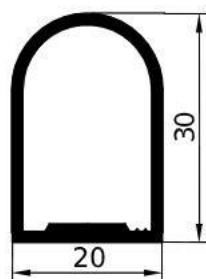

**GA1606 – gr/ml 378**  
 L/mm.5200  
 PACCO / 10 BARRE

# PROFILI PER TENDE DA INTERNI

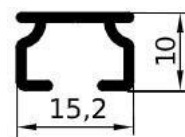
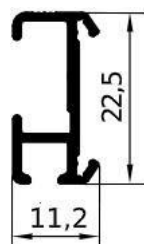
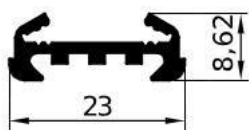
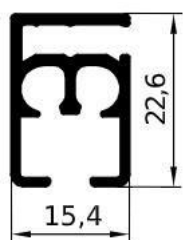

**GA1543 – gr/ml 260**

L/mm.6000

PACCO / 10 BARRE

**GA1604 – gr/ml 168**

VELCRATO L/mm.6000

PACCO / 14 BARRE

**GA1503 – gr/ml 167**

VELCRATO L/mm.6000

PACCO / 10 BARRE

**GA1504 – gr/ml 113**

L/mm.6000

PACCO / 20 BARRE

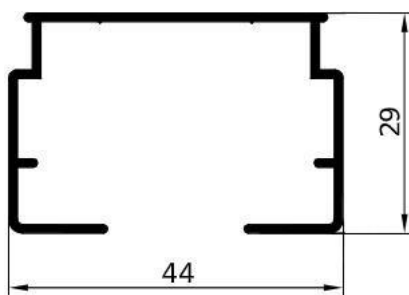

**GA1505 – gr/ml 400**

L/mm.6000

PACCO / 8 BARRE

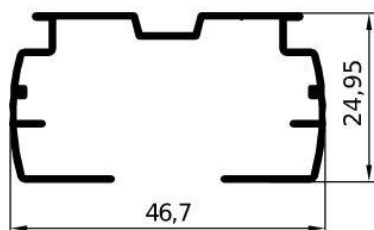

**GA1580 – gr/ml 386**

L/mm.6000

PACCO / 6 BARRE

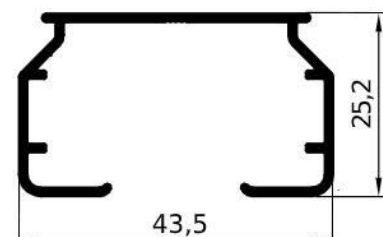

**GA1655 – gr/ml 374**

L/mm.6000

PACCO / 5 BARRE

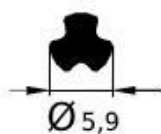

**GA1506 – gr/ml 59**

L/mm.6000

PACCO / 20 BARRE

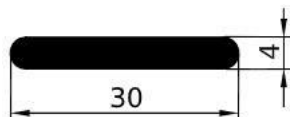

**CPR3004 – gr/ml 315**

L/mm.6000

PACCO / 10 BARRE

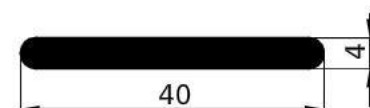

**CPR3003 – gr/ml 423**

L/mm.6000

PACCO / 12 BARRE

# PROFILI PER TENDE DA INTERNI

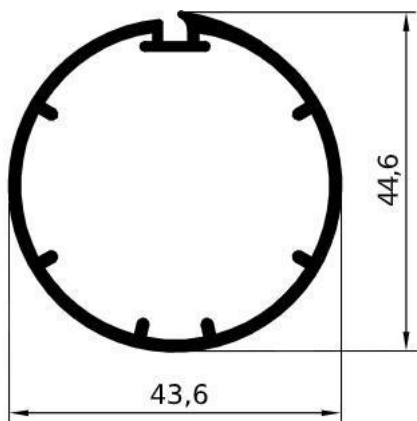

<b>GA1636 – gr/ml 545</b>
L/mm.6000
PACCO / 5 BARRE

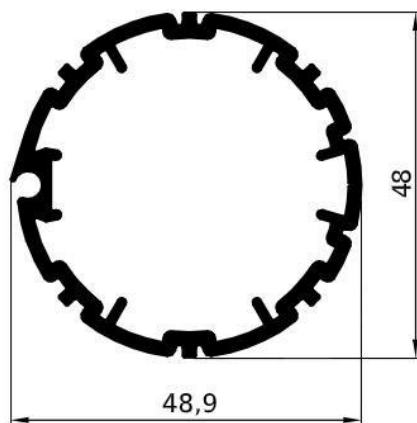

<b>GA1651 – gr/ml 980</b>
L/mm.6000
PACCO / 5 BARRE

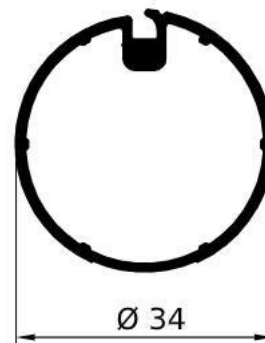

<b>GA1654 – gr/ml 400</b>
L/mm.6000
PACCO / 5 BARRE

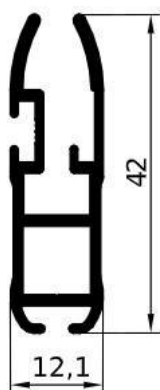

<b>GA1650 – gr/ml 417</b>
L/mm.6000
PACCO / 5 BARRE

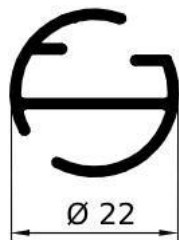

<b>GA1658 – gr/ml 263</b>
L/mm.6000
PACCO / 5 BARRE

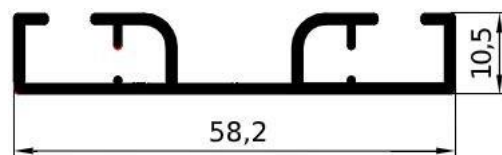

<b>GA1574 – gr/ml 461</b>
L/mm.6000
PACCO / 10 BARRE

# PROFILI SPECIALI

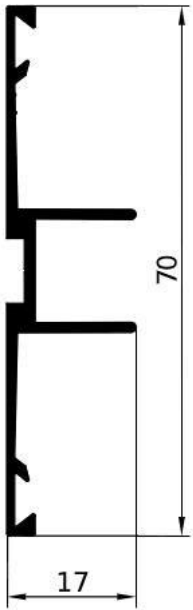

<b>GA1629 – gr/ml 411</b>
L/mm.6000
PACCO / 10 BARRE

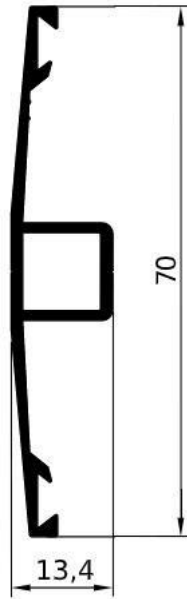

<b>GA1630 – gr/ml 433</b>
L/mm.6000
PACCO / 10 BARRE

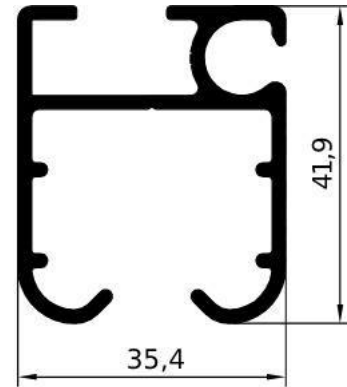

<b>GA1681 – gr/ml 820</b>
L/mm.5000 – 7000
PACCO / 5 BARRE

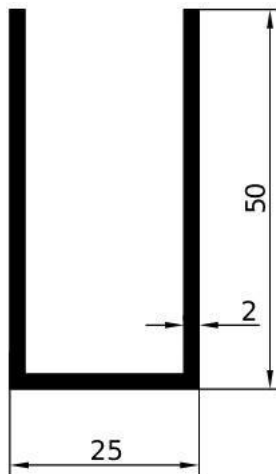

<b>GA1682 – gr/ml 653</b>
L/mm.6000
PACCO / 6 BARRE

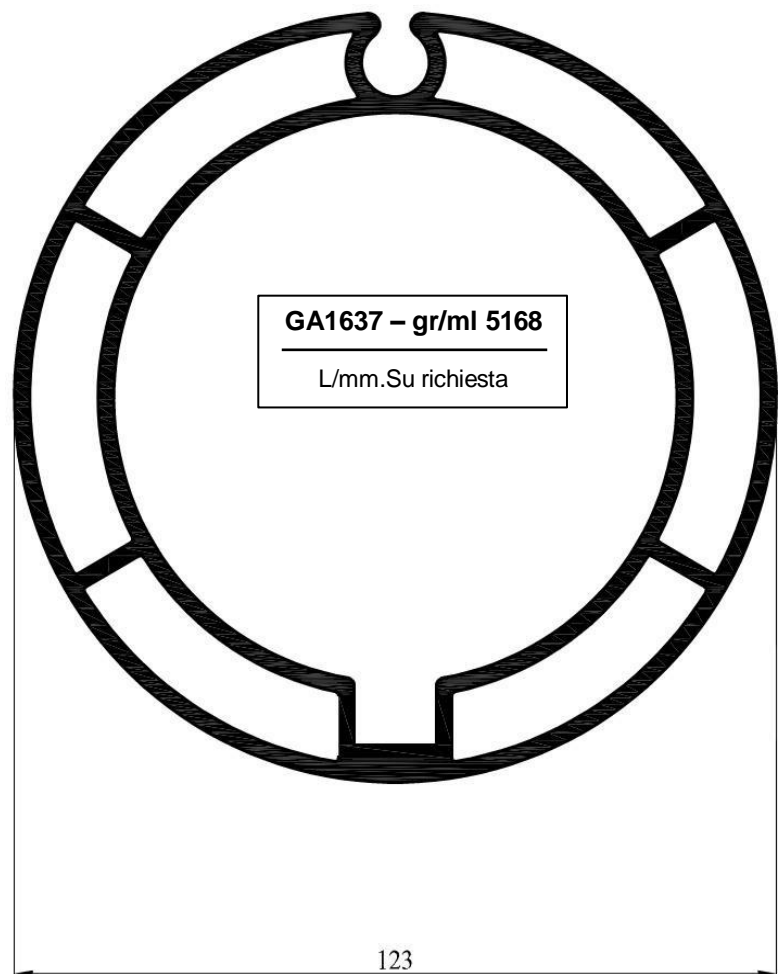

<b>GA1637 – gr/ml 5168</b>
L/mm.Su richiesta

# PROFILI PER ZANZARIERE

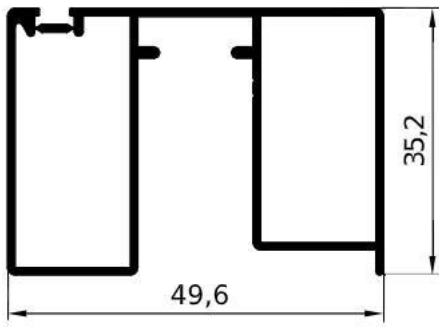

**GA1594 – gr/ml 618**  
**MIN KG.500**

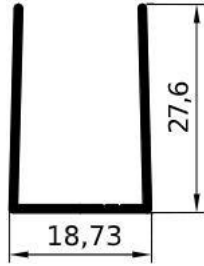

**GA1596 – gr/ml 278**  
**MIN KG.500**

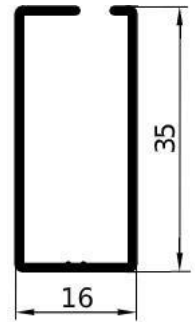

**GA1595 – gr/ml 213**  
**MIN KG.500**

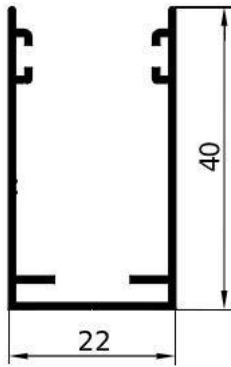

**GA1546 – gr/ml 298**  
**MIN KG.500**

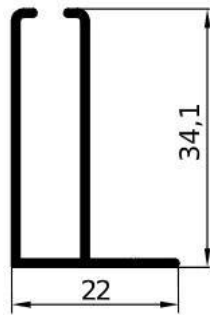

**GA1532 – gr/ml 270**  
**MIN KG.500**

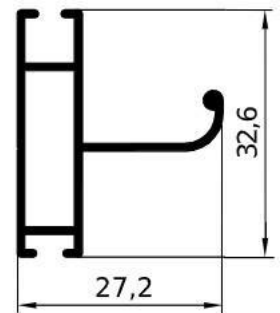

**GA1533 – gr/ml 300**  
**MIN KG.500**

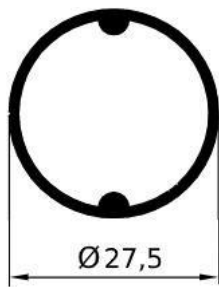

**GA1545 – gr/ml 310**  
**MIN KG.500**



**GA1568 – gr/ml 307**  
**MIN KG.500**

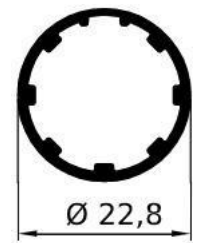

**GA1583 – gr/ml 270**  
 L/barre mm.6000  
**PACCO / 10 BARRE**

# PROFILI PER ZANZARIERE

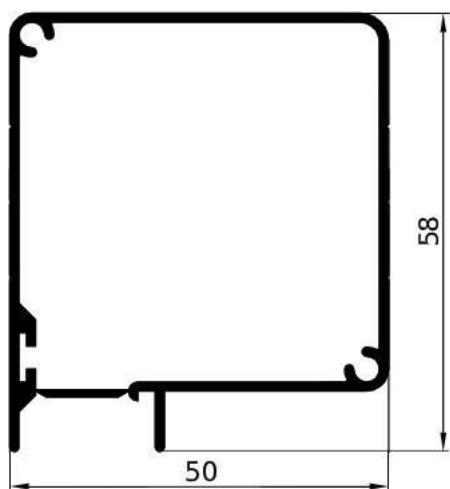

**GA1535 – gr/ml 704**  
**MIN KG.500**

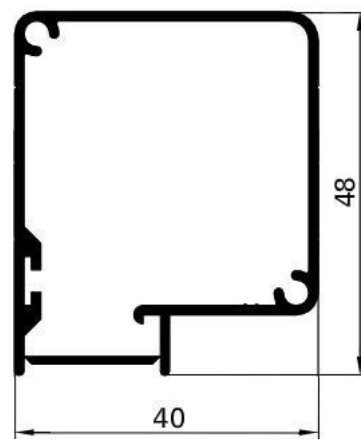

**GA1534 – gr/ml 575**  
**MIN KG.500**

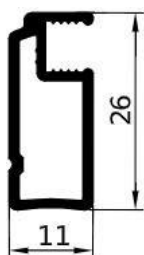

**GA1544 – gr/ml 256**  
L/mm.6000  
**PACCO / 10 BARRE**



**GA1582 – gr/ml 277**  
L/mm.6000  
**PACCO / 10 BARRE**

# PROFILI PER TELONI

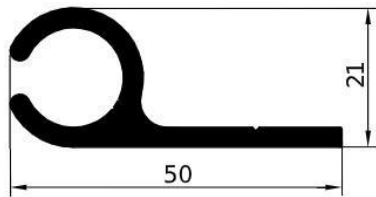

**GA1627 – gr/ml 715**  
L/mm.6000  
PACCO / 6 BARRE

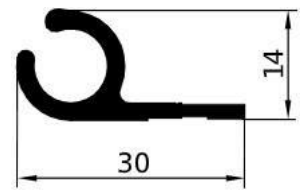

**GA1548 – gr/ml 283**  
L/mm.7000  
PACCO / 10 BARRE

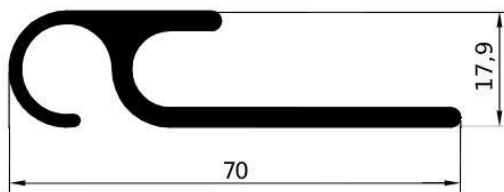

**GA1552 – gr/ml 863**  
L/mm.6500  
PACCO / 4 BARRE

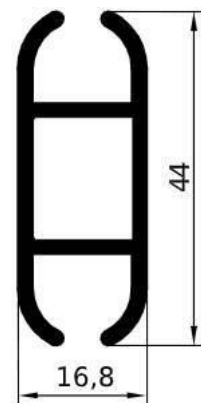

**GA1576 – gr/ml 582**  
L/mm.6000  
PACCO / 5 BARRE

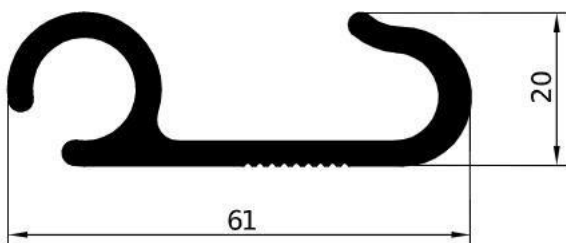

**GA1565 – gr/ml 962**  
L/mm.7500  
PACCO / 6 BARRE

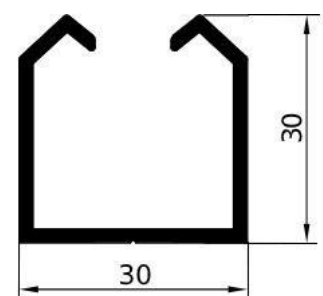

**GA1608 – gr/ml 475**  
L/mm.6000  
PACCO / 10 BARRE



# PROFILI SPECIALI

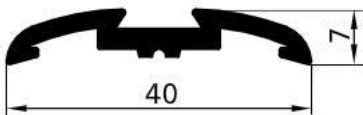

**GA1527 – gr/ml 310**  
L/mm.7000  
PACCO / 20 BARRE

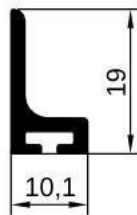

**GA1665 – gr/ml 165**  
L/mm.6500  
PACCO / 10 BARRE

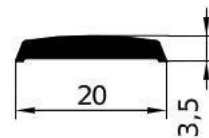

**GA1635 – gr/ml 135**  
L/mm.6000  
PACCO / 20 BARRE

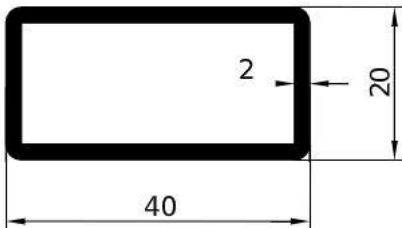

**CTR3022R – gr/ml 597**  
L/mm.6000

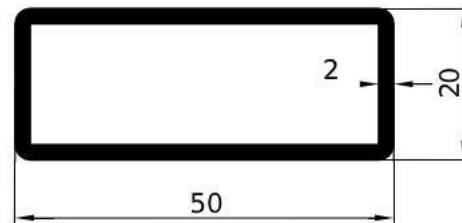

**CTR3031R – gr/ml 705**  
L/mm.6000

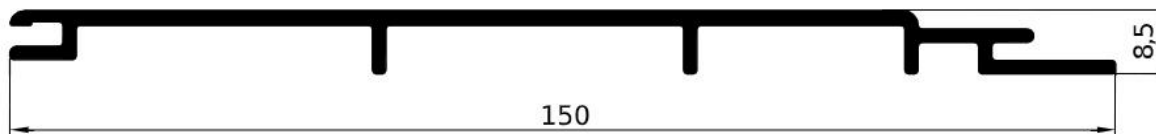

**GA1547 – gr/ml 984**  
L/mm.7500  
PACCO / 2 BARRE

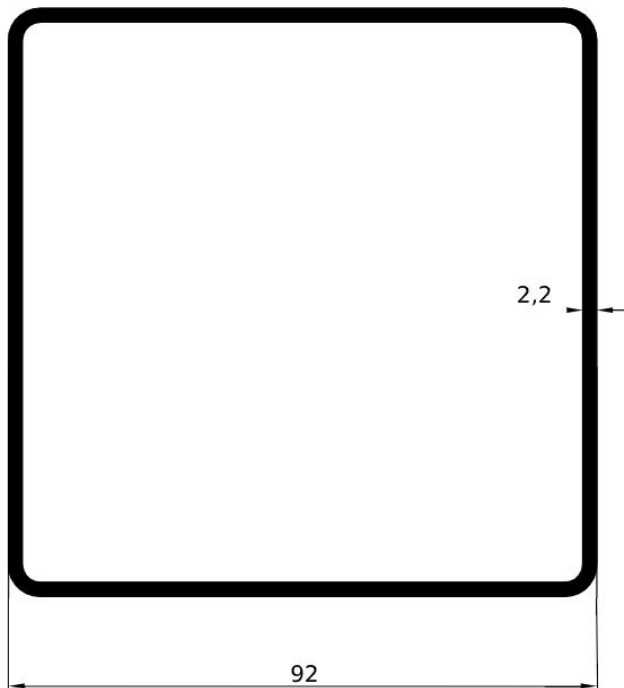

**GA1502 – gr/ml 2095**  
L/mm.4500-5100

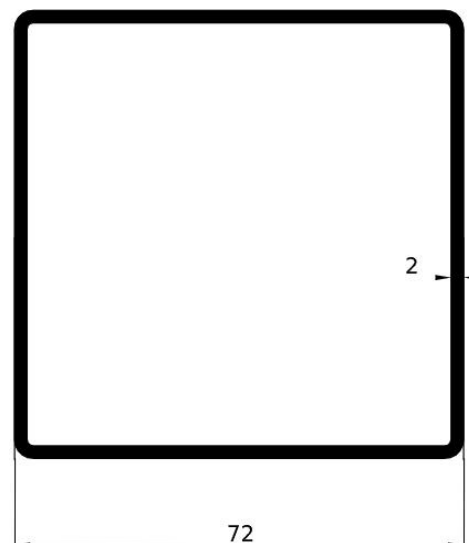

**GA1555 – gr/ml 1495**  
L/mm.5400

# PROFILI SPECIALI

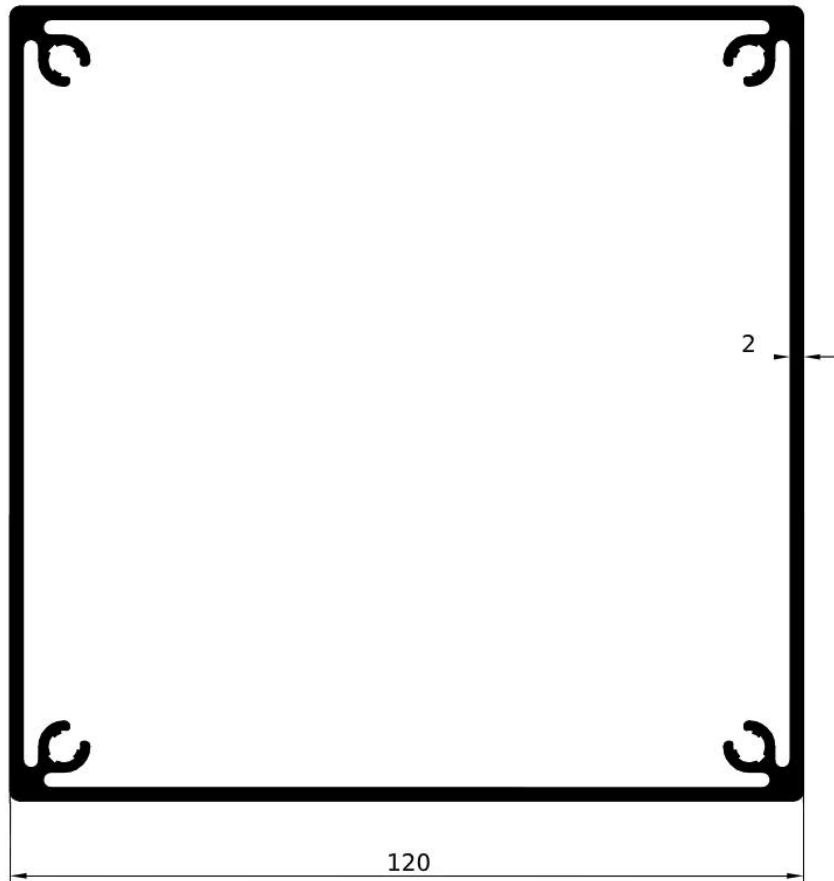

**GA1641- gr/ml 2924**

L/mm.7000

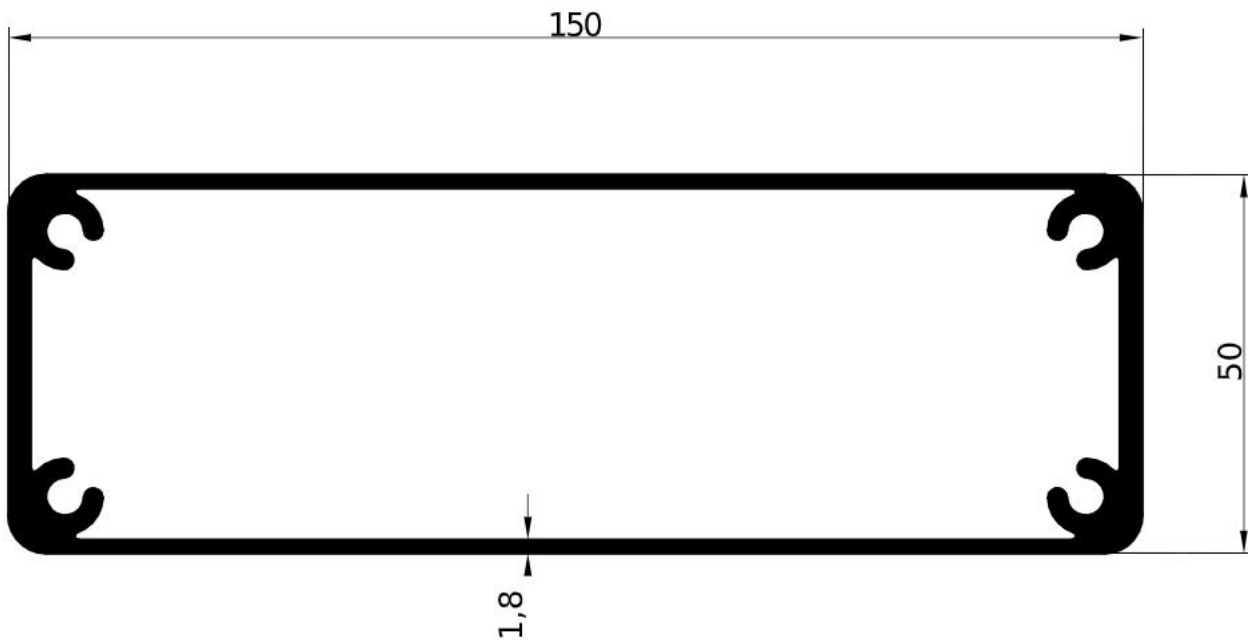

**GA1642 - gr/ml 2751**

L/mm.7000

# PROFILI SPECIALI

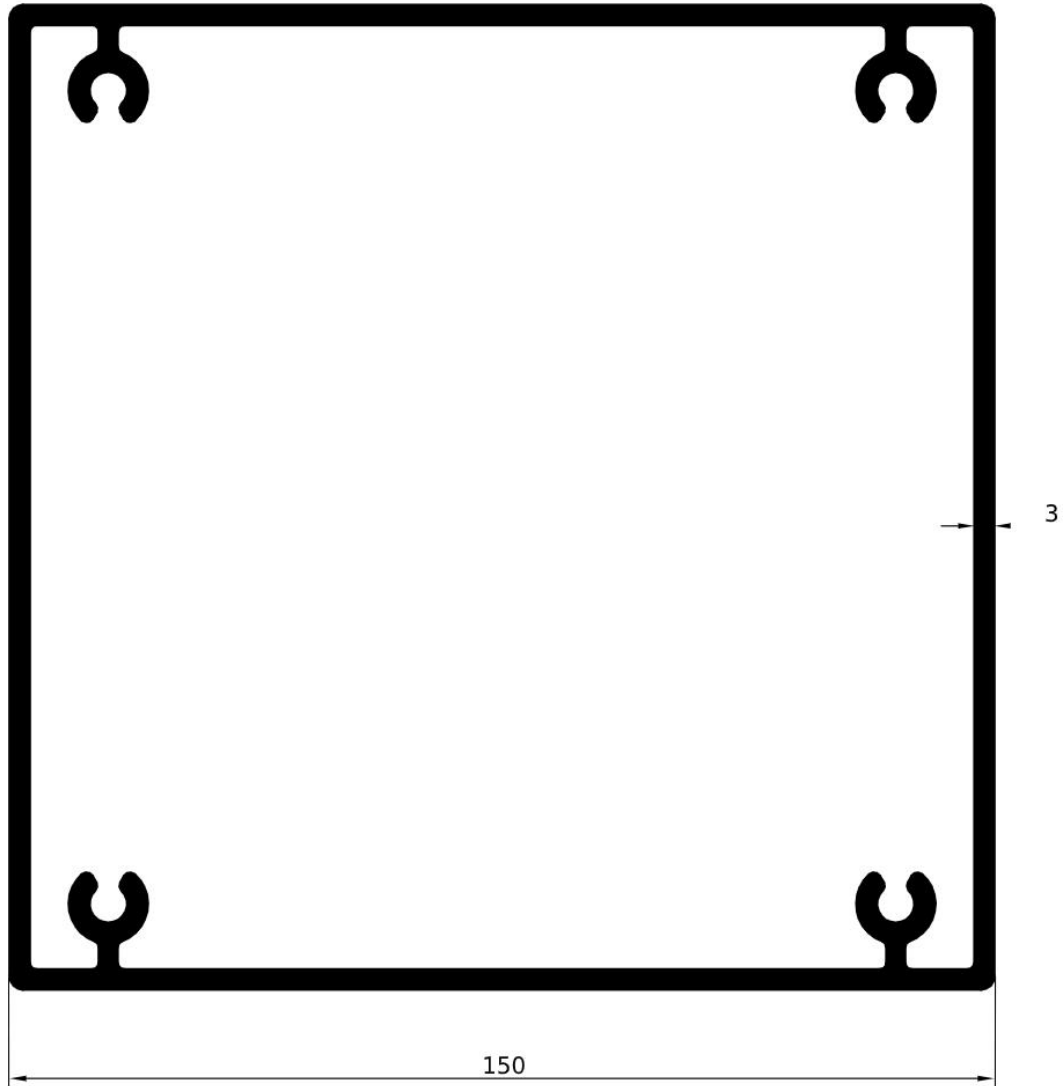

**GA1659 – gr/ml 5655**

L/mm.7000

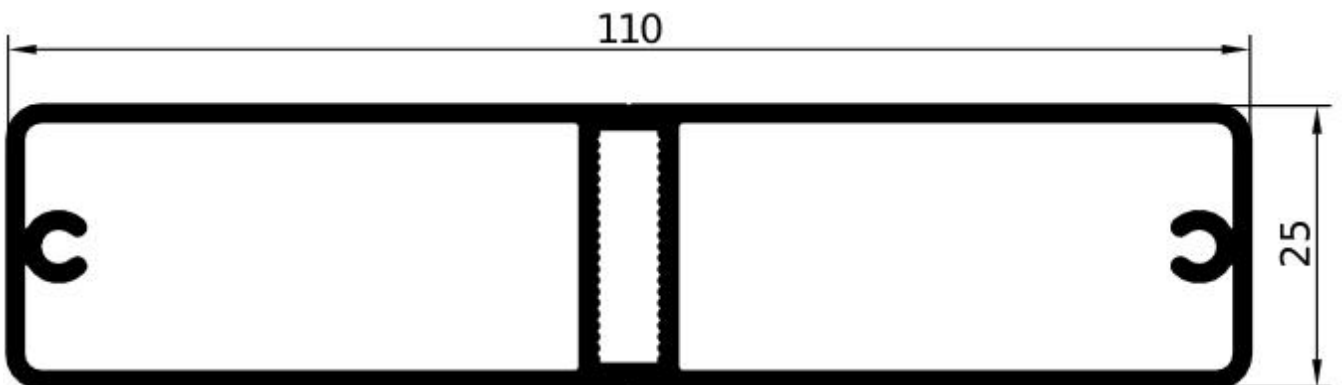

**GA1648 – gr/ml 1194**

L/mm.6500

# PROFILI SPECIALI

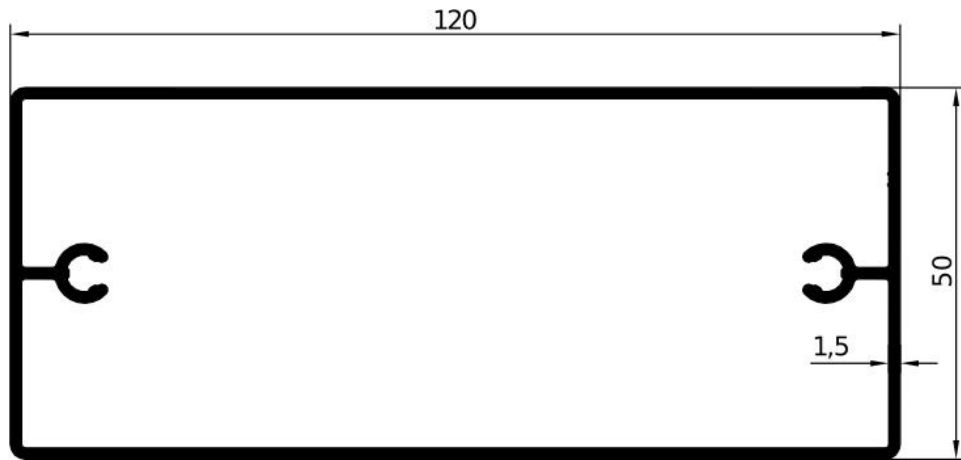

**GA1696 – gr/ml 1522**  
L/mm.6000

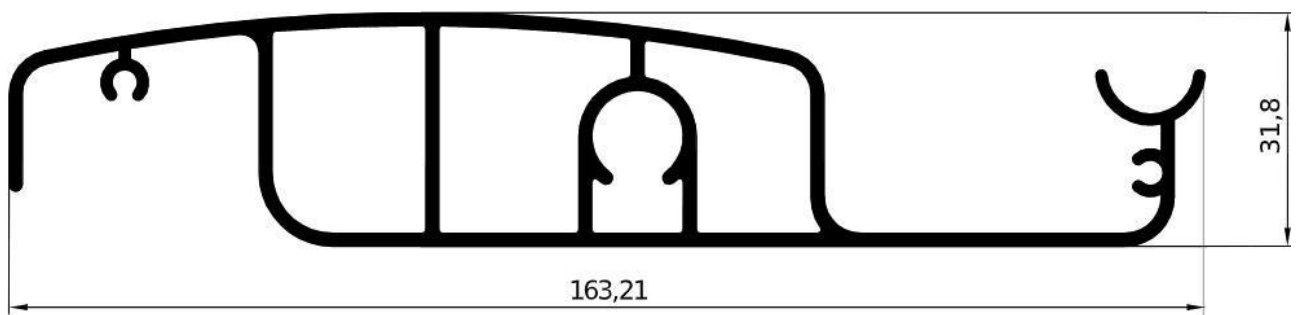

**GAS-232 – gr/ml 2074**  
L/mm.Su richiesta

# PROFILI SPECIALI

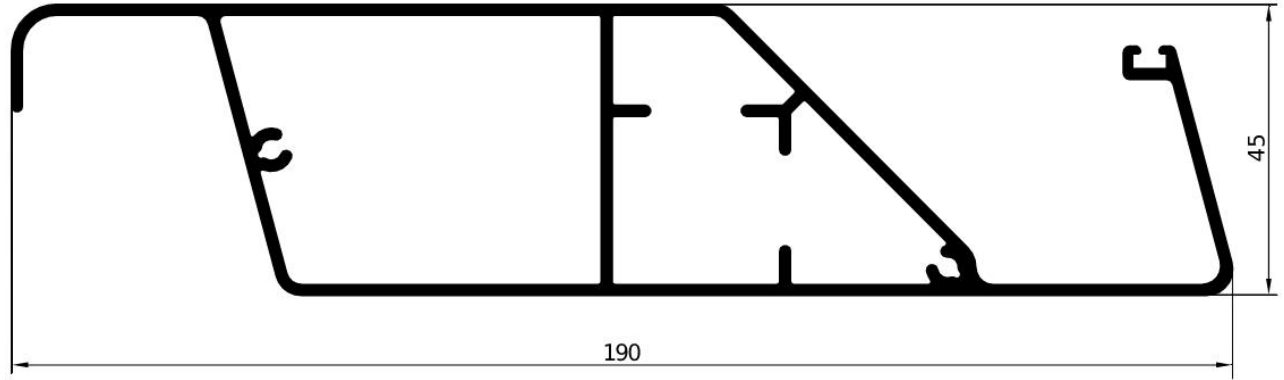

**GA1664 – gr/ml 2085**

L/mm.Su richiesta

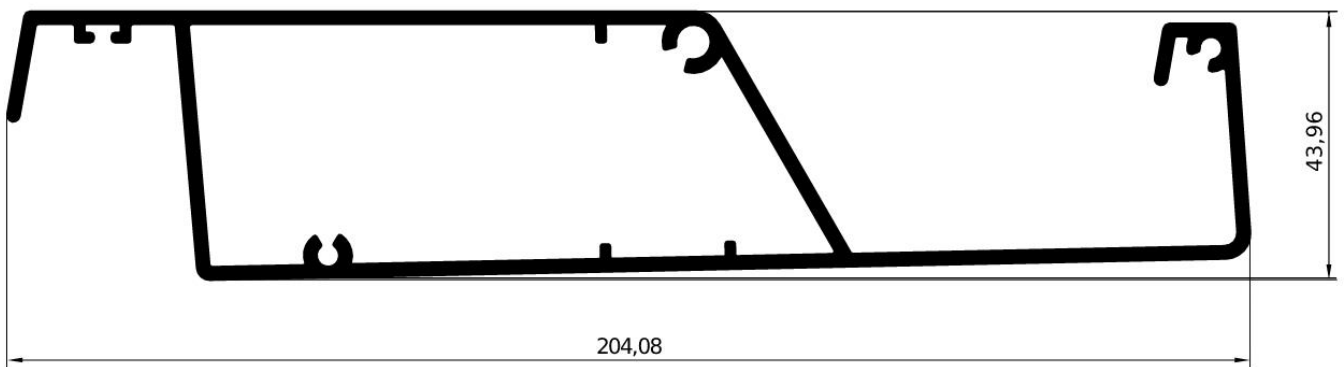

**GA1660 – gr/ml 2584**

L/mm.Su richiesta

# MODULO ORDINI

## GALTAROSSALLUMINIO S.R.L.

Sede: legale e amministrativa: Via del Commercio , 18  
 35036-MONTEGROTTO TERME – PD-  
 Cod.Fisc e Partita IVA:04545400287  
 www.galtarossalluminio.com  
 E-mail: [commerciale@galtarossalluminio.com](mailto:commerciale@galtarossalluminio.com)  
 E-mail: [amministrazione@galtarossalluminio.com](mailto:amministrazione@galtarossalluminio.com)  
 TEL / 049-795363 - Fax 049-795565

ALLA C/A Sig.

<b>Cliente:</b>			
Via ;			
Cap :	Città :	Prov :	
<b>Destinazione:</b>			
Spedizione a mezzo:		Resa:	
<b>Pagamento:</b>			

Lega: ENAW 6060	Stato fisico: <b>T5</b>	}
Imballo:		

POS.	Cod. GALTAROSSALLUMINIO	Quantità da Ordinare					Tempi di Consegna Prevista	Costo
		N° Barre / Pz	KG	MT	L( mm )	FINITURA		
1								
2								
3								
4								
5								
6								
7								
8								
9								
10								
11								
12								
13								
14								
15								

Data :	NOTE :
Firma :	

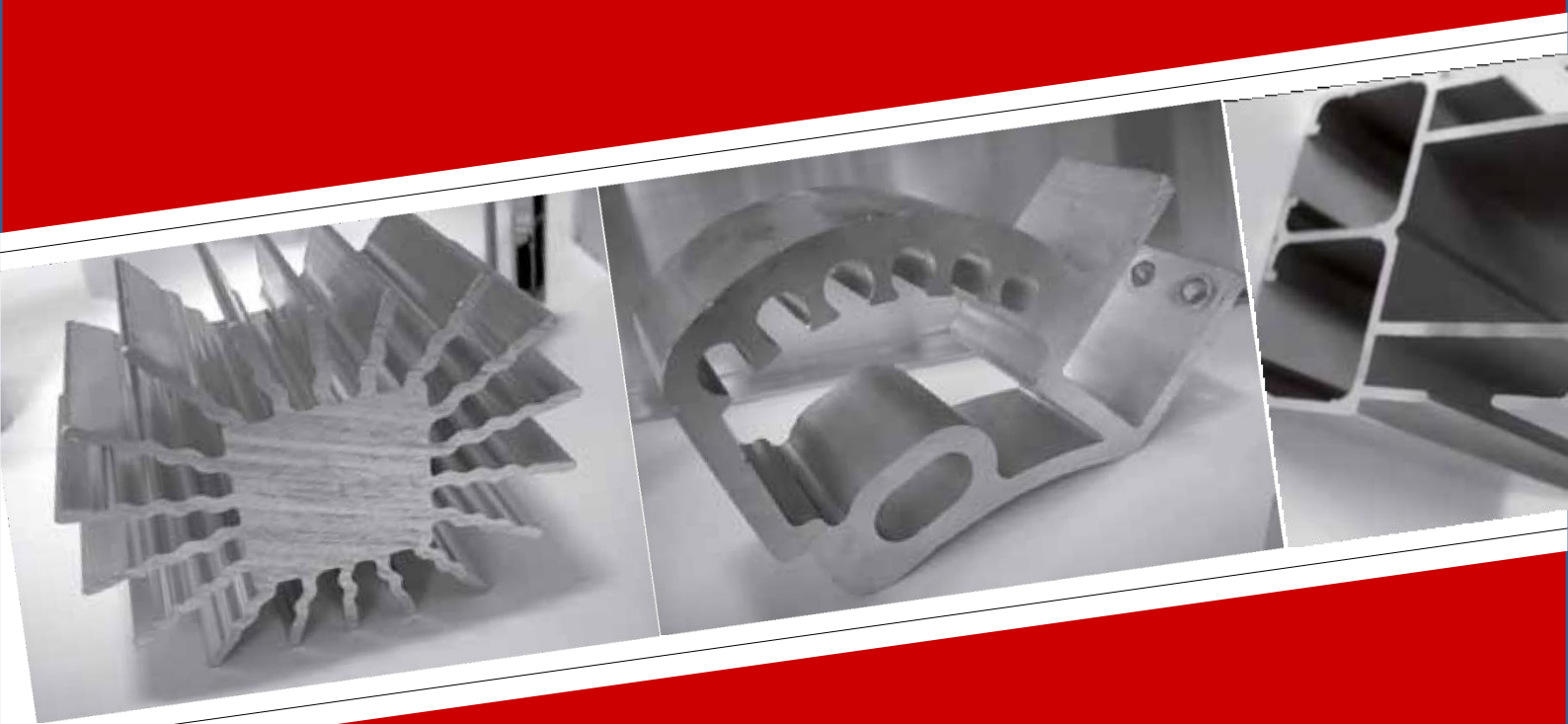

**GALTAROSSALLUMINIO**  
PROFILI SPECIALI

GALTAROSSALLUMINIO s.r.l.  
via del Commercio , 18 35036  
Montegrotto Terme (PD)  
Tel. 049.795363 - Fax 049.795565  
[commerciale@galtarossalluminio.com](mailto:commerciale@galtarossalluminio.com)